

## HH-521BT

4-Channel Thermocouple Data Logger (with Bluetooth)  
(Types K, J, T, N, E, R, S)

## Instruction Manual



# CONTENTS

<b>1. GENERAL DESCRIPTION .....</b>	<b>2</b>
<b>2. SAFETY INFORMATION .....</b>	<b>2</b>
<b>3. FEATURES.....</b>	<b>2</b>
<b>4. SPECIFICATIONS .....</b>	<b>3</b>
<b>5. SYMBOL DEFINITION &amp; BUTTON LOCATION .....</b>	<b>4</b>
<b>6. BUTTON INSTRUCTIONS .....</b>	<b>6</b>
6.1 Power ON/OFF Button .....	6
6.2 Backlight Button .....	6
6.3 Data-Hold Button .....	6
6.4 REC Button.....	6
6.5 MEM Button .....	6
6.6 RECALL Saved Reading Button.....	6
6.7 MAX/MIN/AVG Button .....	7
6.8 Selecting Temperature Units .....	7
6.9 SETUP Button .....	7
<b>7. OPERATING INSTRUCTIONS .....</b>	<b>7</b>
7.1 Setup Options .....	7
7.2 Menu Item.....	7
7.3 Menu Description .....	9
7.3.1 Set Bluetooth ON/OFF .....	9
7.3.2 Select thermocouple type: K, J, E, T, N, R or S .....	9
7.3.3 Setting interval time for data storing .....	10
7.3.4 Set offset to compensate for probe errors .....	10
7.3.5 Set alarm point (only for channel T1).....	10
7.3.6 Set T1-T2 subtraction mode .....	11
7.3.7 Set auto power off time .....	11
7.3.8 Set system clock .....	11
7.4 Clearing Data Logger Records .....	11
7.5 Clearing Instant Read-out Memory.....	12
7.6 Connecting to a computer .....	12
<b>8. POWER AND BULETOOTH ADAPTER PREPARATION .....</b>	<b>12</b>
8.1 Battery Replacement .....	12
8.2 Bluetooth Adapter Installation.....	13
<b>9. MAINTENANCE .....</b>	<b>13</b>
<b>10. TESTLINK SE-521 SOFTWARE.....</b>	<b>14</b>

## 1. GENERAL DESCRIPTION

Thank you for choosing our data logger thermometer. To ensure the safety and the best performance of this instrument, we recommend you to read and follow the manual carefully before operation.

Data can be stored in the meter or directly saved on a computer through PC interface. Recorded data can be further processed by PC computer.

## 2. SAFETY INFORMATION

Read the following safety information carefully before attempting to operate or service the meter. Use the meter only as specified in this manual; otherwise, the protection provided by the meter may be impaired.

### ENVIRONMENT CONDITIONS

- Altitude up to 2000 meters
- Relatively humidity: 90% max
- Operation ambient temperature: 0°C to 50°C

### MAINTENANCE & CLEANING

- Repairs or servicing not covered in this manual should only be performed by qualified personnel.
- Periodically wipe the case with a dry cloth. Do not use abrasives or solvents on this instrument.

### SAFETY SYMBOLS

 Comply with EMC

When servicing, use only specified replacement parts.

## 3. FEATURES

- Four-channel inputs
- Support K, J, E, T, N, R, S type thermocouple
- Temperature alarm function
- Fast response and sampling rate
- 32000 data logger records each channel
- Instant recall function
- Wirelessly connect to PC or mobile device via Bluetooth Adapter
- iOS and Android APP available to download from APP store
- USB PC interface with Windows software included
- Adjustable auto power off timer

## 4. SPECIFICATIONS

<b>Measurement range :</b>	K: -200°C ~1372°C (- 328°F ~ 2501°F) J: -200°C~1000°C (- 328°F ~ 1832°F) E: -200°C~750°C (- 328°F ~ 1382°F) T: -200°C~400°C (-328 °F ~ 752°F) N:-200°C ~1300°C(- 328°F ~ 2372°F) R, S: 0°C ~1767°C( 32°F ~ 3212°F)
<b>Resolution :</b>	K-,J-,E-,T-,N-type 0.1°C < 600°C / 0.1°F < 1000°F, 1°C ≥ 600°C / 1°F ≥1000°F R-,S-type 0.2°C < 600°C / 0.5°F < 1000°F 1°C ≥ 600°C / 1°F ≥1000°F
<b>Accuracy :</b>	J-,K-,E-,T-,N-type: ±(0.1% of reading+0.7°C) ±(0.1% of reading+1.3°F) below -100°C ( -148°F ) ±(0.5% of reading +0.7°C) ±(0.5% of reading +1.3°F) R- and S-type: ±(0.2% of reading+1.4°C) ±(0.2% of reading+2.5°F)
<b>Temperature coefficient :</b>	0.01% of reading + 0.05°C(0.0028°F) per °C [<18°C(64°F) or >28°C(82°F)]
<b>Sample rate :</b>	2 time per second
<b>Battery type :</b>	UM-4 or AAA 1.5V battery x 4
<b>Battery lifetime :</b>	Bluetooth OFF: Approx. 120 hours (alkaline battery) Bluetooth ON: Approx. 30 hours (alkaline battery)
<b>Operation temperature :</b>	0°C to 50°C (32°F to 122°F)
<b>Operation humidity :</b>	10 to 90%RH (no condensing)
<b>Storage temperature :</b>	-20°C to 60°C (-4°F to 140°F)
<b>Storage humidity :</b>	10 to 75%RH
<b>Dimensions/ Weight :</b>	187mm(L) × 75mm(W) × 29mm(H)/ Approx. 290g
<b>Standard Accessories :</b>	Instruction manual, battery 1.5V AAA x 4 pcs, Windows software, micro USB cable, K type bead probe x 2 pcs, carrying case.

## 5. SYMBOL DEFINITION & BUTTON LOCATION

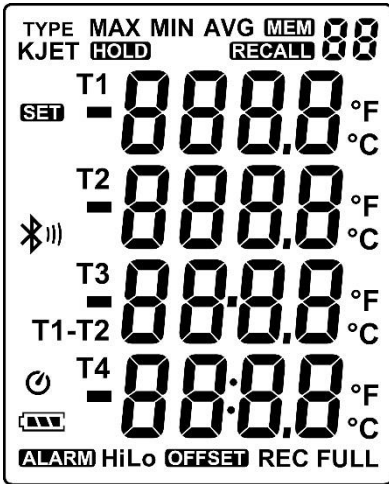

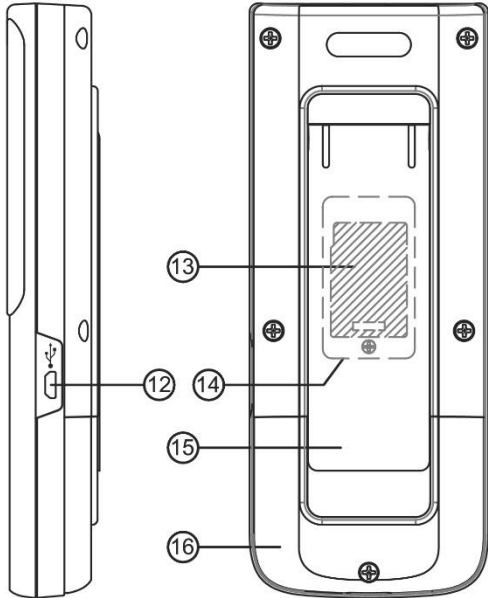
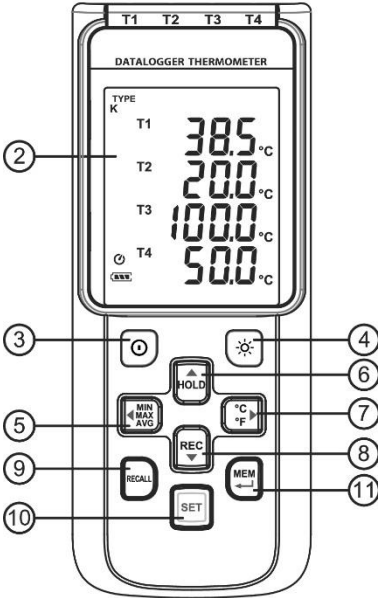
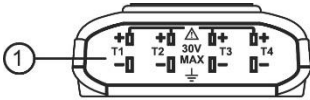

	: Battery condition indicator
<b>MIN</b>	: Minimum indicator
<b>MAX</b>	: Maximum indicator
<b>AVG</b>	: Average indicator
<b>SET</b>	: Setup option indicator
	: Auto Power Off enabled indicator
<b>REC</b>	: Recording data logger indicator
<b>FULL</b>	: Memory full indicator
<b>MEM</b> 88	: Memory group indicator
<b>RECALL</b> 88	: Recall Memory group reading indicator
<b>TYPE</b> KJET	: Thermocouple type
-8888	: Temperature reading
<b>T1 T2 T3 T4</b>	: Temperature channel
<b>T1-T2</b>	: Temperature subtraction mode
<b>ALARM</b>	: Temperature alarm indicator
<b>Hi</b>	: Hi Temperature alarm indicator
<b>Lo</b>	: Lo Temperature alarm indicator
<b>OFFSET</b>	: Compensate for probe errors
<b>°C °F</b>	: Temperature measurement units
<b>HOLD</b>	: Data hold indication
	: Bluetooth indicator (Connecting mode)
	: Bluetooth indicator (Standby/Pairing mode)
	: Thermocouple type (N type)
	: Thermocouple type (R type)
	: Thermocouple type (S type)





- 
- |                         |                                  |
|-------------------------|----------------------------------|
| (1) Thermocouple Input  | (9) RECALL Saved Reading Button  |
| (2) Display Screen      | (10) SETUP Button                |
| (3) Power ON/OFF Button | (11) MEM Button (Set 100 Memory) |
| (4) Back Light Button   | (12) USB Interface               |
| (5) MAX MIN AVG Button  | (13) Bluetooth Adapter           |
| (6) DATA HOLD Button    | (14) Bluetooth Compartment       |
| (7) °C , °F Button      | (15) Tilt Stand                  |
| (8) REC Button          | (16) Battery Compartment         |
-

## 6. BUTTON INSTRUCTIONS

### 6.1 Power ON/OFF Button

Press the  button to turn on the meter. Press and hold  button for 3 seconds to turn off.

### 6.2 Backlight Button

Press  to turn on the LCD backlight. This makes it easier to read in dark environment. Press  again to turn off backlight. The backlight will be automatically turned off after 30 seconds to save battery power.



### 6.3 Data-Hold Button

Press  button to freeze the data shown on the LCD screen. Press it again to exit Data-Hold mode.

**Note:** When the unit is in the Data-Hold mode, , , , and  buttons are disabled.

### 6.4 REC Button



Press  button to start recording data. The “**REC**” symbol will display on the screen. To stop recording, press  button again.

**Note:** During recording period, most of the buttons are disabled, such as the , . All settings must be made before starting the data logger function.

**Note:** When the memory is full (32,000 recorders), “**FULL**” symbol will blink on the LCD screen. The data logger stops.

**Note:** When battery power is low ( “ ” symbol lights up on the screen), data logger cannot be started. If the battery is running low during data logging, it will stop recording automatically.





### 6.5 MEM Button

Press  button to save readings on the LCD screen. The “**MEM 88**” symbol lights up on the screen for 2 seconds. Press the  button again to store next group readings. The store readings on the LCD screen for 00~99 group.

### 6.6 RECALL Saved Reading Button

Press the  button to recall saved readings. The “**RECALL 88**” symbol lights up on the screen.

**Note:** When the meter is during connection section, this function is disabled.





Press the , , , or  button to select MEM group. The LCD shows “**hour:minute:second**” on the screen for 2 seconds, and then shows the readings.

Press  or  button to exit RECALL mode.

## 6.7 MAX/MIN/AVG Button

Under this mode, the unit simultaneously monitors and stores the maximum, minimum and average value in the memory. The unit will keep updating/refreshing the data.

### To start:

- (1) Press  button. “**MAX**” symbol lights up on LCD, the reading shows the maximum data.
- (2) Press  button again to show minimum data; the “**MIN**” symbol lights up on LCD.
- (3) Press  button again to show average data; the “**AVG**” symbol lights up on LCD.
- (4) Press  button again, the “**MAX, MIN and AVG**” symbol blinks together, the readings shows real time data.



### To exit MAX/MIN/AVG mode:

Press and hold  button for 2 seconds to exit MAX/MIN/AVG mode.

## 6.8 Selecting Temperature Units

Press the  button to switch between Celsius (°C) and Fahrenheit (°F).







## 6.9 SETUP Button

Press the  button to enter setup options. Press  again to exit setup mode anytime.

**Note:** When the meter is during connection section, setup options cannot be entered.

# 7. OPERATING INSTRUCTIONS

## 7.1 Setup Options

- (1) Press the  button to enter setup options. Press it again to exit anytime.
- (2) Using the     button to adjust parameters or move setting items.
- (3) Press the  button to save changes and move to next setting option.

## 7.2 Menu Item

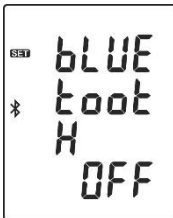

(1) Fig.1 Set Bluetooth ON/OFF.



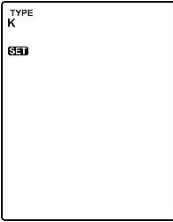

(2) Fig.2 Set thermocouple type.



(3) Fig.3 Set interval time for data logging.

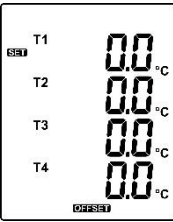

(4) Fig.4 Set offset to compensate for probe errors.



(5) Fig.5 Set alarm point.



(6) Fig.6 Set T1-T2 subtraction mode.



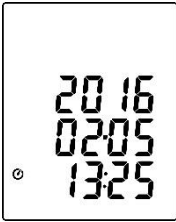

(7) Fig.7 Set auto power off time.



(8) Fig.8 Set system clock.

### 7.3 Menu Description

#### 7.3.1 Set Bluetooth ON/OFF

Press the  or  button to turn on or off. (see Fig.9 or Fig.10)

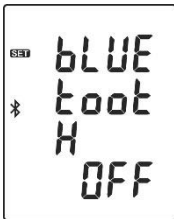

Fig.9

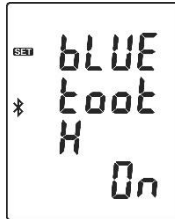





Fig.10

**Note:**

When Bluetooth function is turned ON, it is entering standby/pairing mode, the blue LED built in  flashes once every 3 seconds. When successfully connected, the blue LED quickly flashes thrice every 3 seconds.

#### 7.3.2 Select thermocouple type: K, J, E, T, N, R or S

Press the  or  button to select thermocouple type. (see Fig. 11)

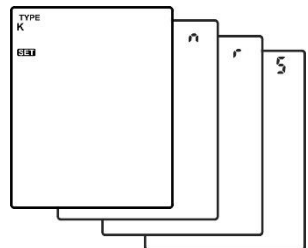





Fig.11

### 7.3.3 Setting interval time for data storing

- (1) Press the  or  button to set minute or second. (see Fig.12)
- (2) Press the  /  button to increase / decrease value.

**Note:**

Set interval time range: 1  
 Second (00:01) to 60 minutes 59 seconds (60:59)

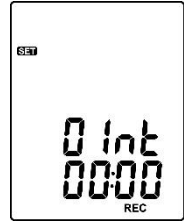

Fig.12

### 7.3.4 Set offset to compensate for probe errors

The user can adjust the readings of thermometer to compensate for the errors against a specific thermocouple.

- (1) Press the  or  button to select thermocouple channel. (see Fig.13)  
 Setting thermocouple channel blinks on the LCD screen.

- (2) Press the  /  button to increase / decrease value.

**Note:**

The offset to compensate for probe errors range:  $\pm 5^{\circ}\text{C}$  or  $\pm 9^{\circ}\text{F}$ .

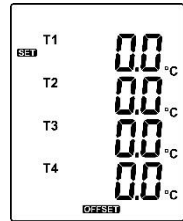





Fig.13

### 7.3.5 Set alarm point (only for channel T1)

Want to set window. (see Fig.14 or Fig.15)

- (1) Press the  or  button to turn on or off.
- (2) When setting on mode, press the  button to set Hi and Lo limit. (see Fig.16)

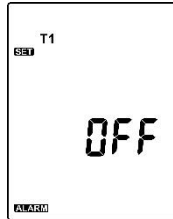

Fig.14

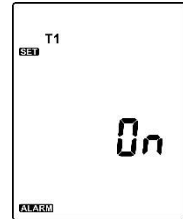

Fig.15

**Note:**

When measuring thermocouple value over alarm point, the symbol will blink "ALARM Hi" or "ALARM Lo" on the LCD. The beeper will make a "beep-beep-beep" sound. The Lo alarm set cannot be greater than Hi alarm set.

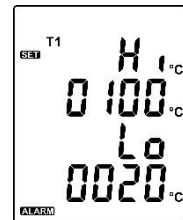



Fig.16

### 7.3.6 Set T1-T2 subtraction mode

Press the  or  button to turn on or off T1-T2 subtraction mode. (see Fig.17 or Fig.18)

**Note:**

When setting T1-T2 subtraction mode on, T1-T2 will display at the bottom of LCD. (see Fig.19)



Fig.17

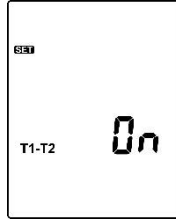

Fig.18

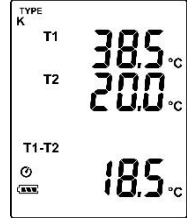

Fig.19

### 7.3.7 Set auto power off time

Press the  or  button to select auto power off option 10, 30 minutes, 1, 2, 4, 8 hours, or off.

(see Fig.20 or Fig.21)



Fig.20

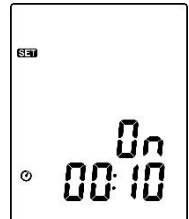





Fig.21

### 7.3.8 Set system clock

The unit is built-in a clock so that the data logger function can also record the data and time along with the measurement value.

(1) Press the  or  button to select year, date, or time.

(see Fig.22)

(2) Press the  /  button to increase / decrease value.

**Note:**

Check the clock setting after replacing batteries. If necessary, reset system clock.

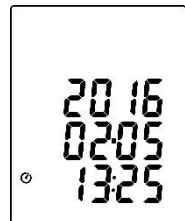





Fig.22





## 7.4 Clearing Data Logger Records

(1) Turn off the unit.

(2) Press and hold  button and then press  power button to turn on the unit.

(3) Keep holding  and  button, then LCD will show "REC", "CLr" and "SURE 5, 4...1, 0" until clean the memory. (To abort, release all buttons in process)

## 7.5 Clearing Instant Read-out Memory

- (1) Turn off the unit.
- (2) Press and hold  button and then press  power button to turn on the unit.
- (3) Keep holding  and  (power) buttons, then LCD will show "**MEM**", "**CLr**" and "**SUR**  
**E 5, 4...1, 0**" until the memory is cleared. (To abort, release  button before "**SUR**  
**E 0**".)  
 The LCD will show "**CLr**", "**0**" and start erasing group 00 to 99 records.

## 7.6 Connecting to a computer

The meter can be connected to PC through a micro USB cable or Bluetooth adapter to download recorded data or perform real time monitoring or datalogging in the software interface.

# 8. POWER AND BULETOOTH ADAPTER PREPARATION

## 8.1 Battery Replacement

- (1) When the battery voltage drops below proper operation range, the  symbol will blink on the LCD display and the battery needs to be replaced.
- (2) Before replacing the battery, power off the meter, and disconnect all temperature probes.  
 Open the cover of the battery cabinet by a screwdriver. Replace the old batteries with four new UM-4 or AAA size batteries.
- (3) Close the battery cabinet cover and fasten the screw.

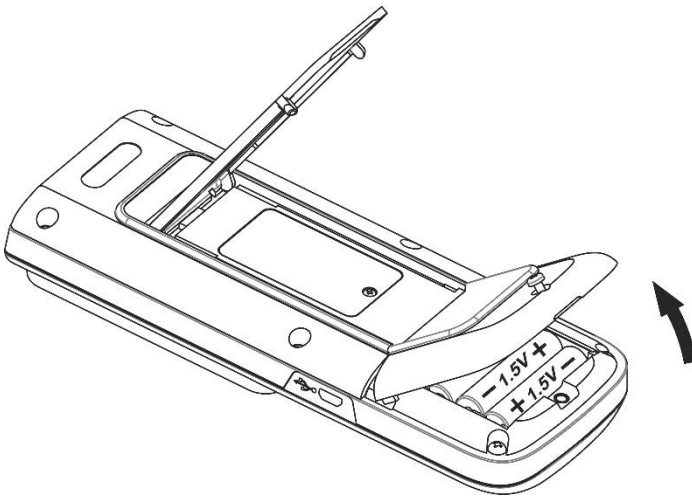

## 8.2 Bluetooth Adapter Installation

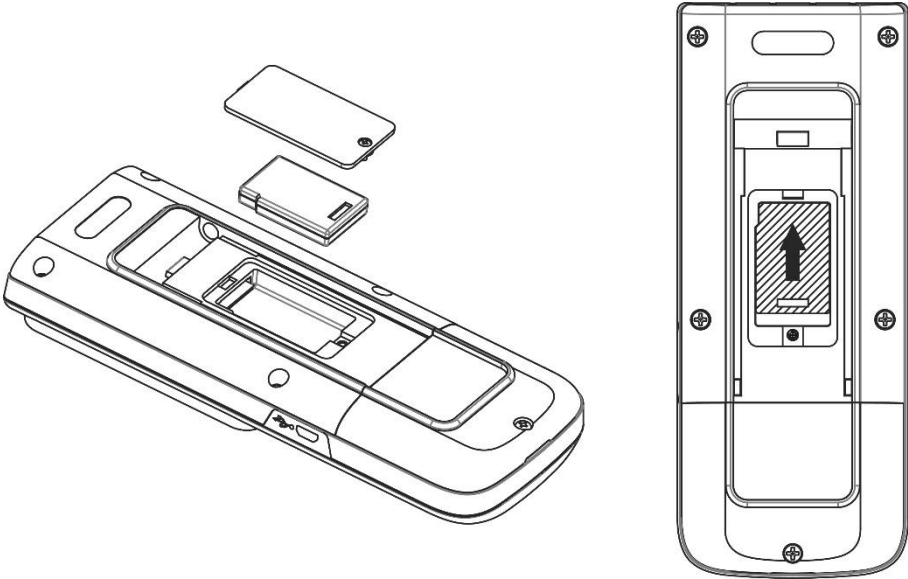

- (1) Power off
- (2) Open the cover of the Bluetooth cabinet by a screwdriver.
- (3) Install the Bluetooth adapter into its compartment, push up the adapter to the connector.
- (4) Close the Bluetooth cabinet cover and fasten the screw.

## 9. MAINTENANCE

In order to ensure the accuracy of the thermometer for a longer period of time you should calibrate it once a year.

Clean the device and the window of the display with a clean, lint-free, antistatic and dry cleaning cloth.

**⚠ Do no use cleaning agents that contain carbon or benzenes, alcohol or anything similar to clean the product since these substances damage the surface of the measuring instrument. Moreover, these fumes are hazardous to health and explosive. Do not use tools with sharp edges, screwdrivers, metal brushes or anything similar to clean the device.**

## 10. TESTLINK SE-521 SOFTWARE

### 10.1 The SE-521 package contains:

- Software CD disk
- Micro USB cable

### 10.2 System Required:

Windows XP/ VISTA/ Windows 7/ Windows 8/ Windows 10

### 10.3 Minimum Hardware Required:

- PC or laptop with CD-ROM drive.
- At least 50 MB hard disk space available to install SE521
- Recommended screen resolution 1024X768 or above.

### 10.4 Tutorial - Quick Start to Use SE521:

#### Recording real time data in waveform:

(1) Power on the 4 Channel Thermometer first and connect it to a PC USB port with the cable.(or set the bluetooth ON)

(2) Start SE521 program, or (Click "search bluetooth device" or  to establish connection.)

**Note:** Before clicking "search bluetooth device" or , make sure bluetooth pairing have finished.

(3) If the connection is successful the panel will display the same value or ( bluetooth symbol  ) as the 4 Channel Thermometer. If fail to connect the meter with PC, it will display " **No Connection** " on the panel window in SE521.

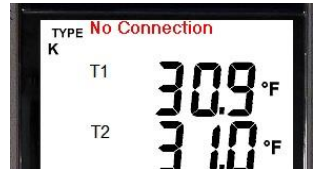

(4) Select sampling rate from Real-Time Graph window.



(5) When the connection is successful, click " **Real Time | run** " or  from main menu to start recording real time data and there will be a waveform on the Real Time Graph Window.

(6) Click " **Real Time | Stop** " or  to stop recording.

### 10.5 How to save the recorded real time data to a file?

- (1) Click the graph window you want to save and the graph window will become active, then choose File | Save from main menu or click from the tool bar .

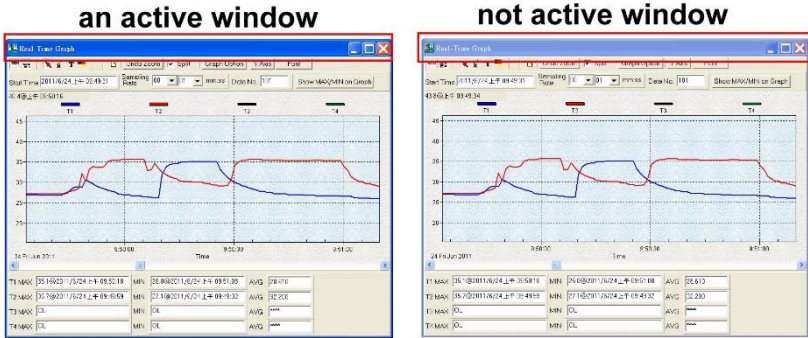

- (2) There will be a save dialog window for you to choose the file name and file type to save. There are three types of file format you can choose, binary file(\*.ghf), text file(\*.txt) and EXCEL format file(\*.csv). The \*.ghf file use much fewer disk space to save the data than the other two file formats, but it can only be used in SE521. Text file can be opened by SE521 and any other word processor program like word, notepad etc. EXCEL format file can be opened by SE521 and Microsoft EXCEL.

**Note:** If decimal separator is comma in your country, this file format will be disabled, because .CSV file also use comma to be data separator. For example 78,6 will become 78 and 6 in EXCEL )

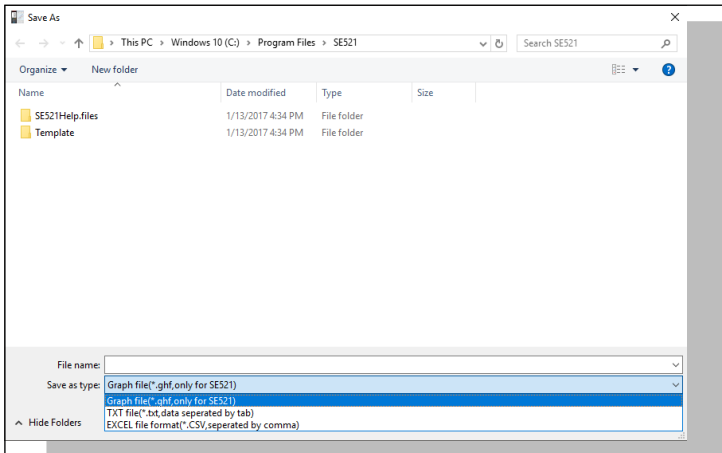



## 10.6 How to load the recorded data from the memory of 4 Channel Thermometer and save it to a file?

- (1) Power on the 4 Channel Thermometer.
- (2) Press the “**REC**” button of the meter to start recording data.
- (3) After a while, press “**REC**” button again to stop recording data.
- (4) Connect the Meter to PC
- (5) Start SE521 program.
- (6) Choose Data Logger from main menu or click  from tool bar.

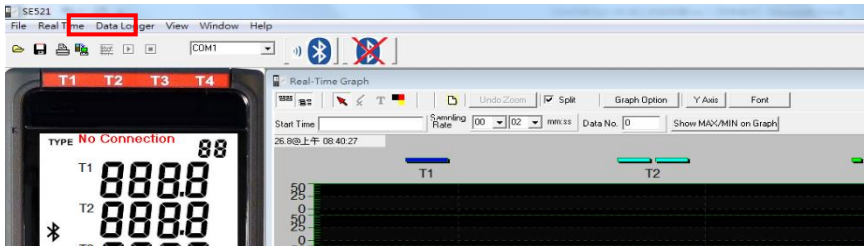

- (7) In reference to Data Logger, see DataLogger

## 10.7 Main Menu:

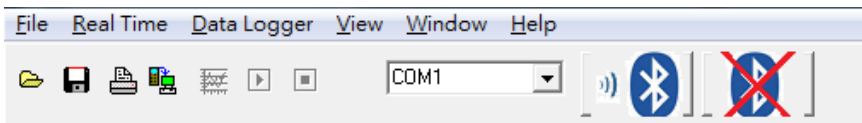

**File | Open**- Retrieve files from the disk.



**Save** - Save the active window (when the caption bar is highlighted) data to the disk.



**Print** - Print the data of the active window (graph or list).

**Printer Setup** - Select printer.

**File | Exit**: Terminates program.

**View | Control Panel:**

By opening the Panel Window, the user can control meter via the button in this window.

**View | Real-Time Graph:**

Open Real-Time Graph display to graph the present data.



**Real Time Data | Run** - Start collecting real time data.



**Stop** - Stop collecting real time data.



**DataLogger:**

By opening the DataLogger Window, the user can load recorded data of meter to PC in this window.



**Output To Graph - Graphing tabular data.**



**Com port of bluetooth device –**

Choose com port to connect to bluetooth device.



**Search Bluetooth Device -**

Automatically searching and connecting to bluetooth device.



**Disconnect Bluetooth Device –** Disconnecting from bluetooth device.

**10.8 DataLogger:**

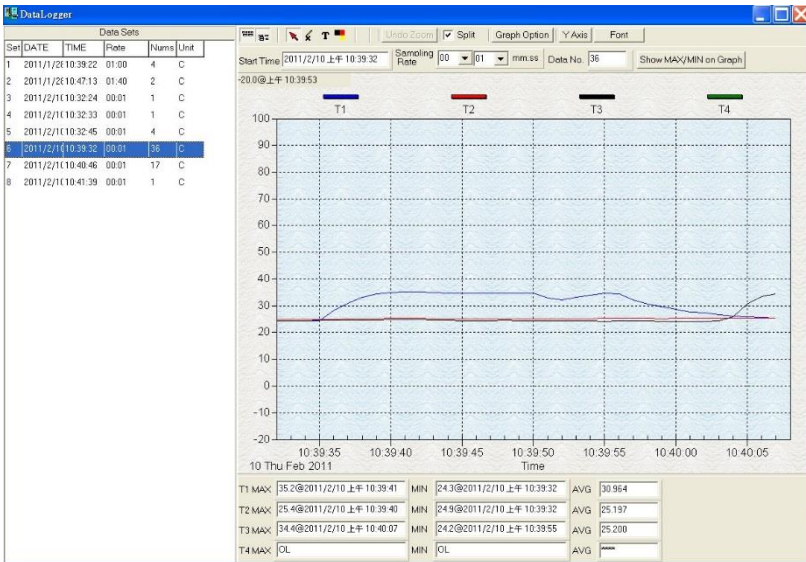

When you have the thermometer connected to a PC, select "**DataLogger**" from the main menu or click the Datalogger icon from the tool bar to load recorded data from the meter and there will be a progress indicator to show the loading status. If an error occurs, just click the "**DataLogger**" icon again.

After the data was downloaded, the left hand side will show how many data sets were loaded and detailed information for each data set (start data, start time, recording rate and record numbers).

Data Sets										
Set	DATE	TIME	Rate	Nums	Unit	Coupl	T1 Offset	T2 Offset	T3 Offset	T4 Offset
1	2016/2/26	16:25:35	00:01	88	F	K	0.0	0.0	0.0	0.0
2	2016/2/26	16:26:49	00:01	26	F	K	0.0	0.0	0.0	0.0
3	2016/2/26	16:27:33	00:01	19	F	K	0.0	0.0	0.0	0.0
4	2016/2/26	16:28:03	00:01	77	F	K	0.0	0.0	0.0	0.0
5	2016/2/26	16:31:34	00:01	11	F	K	0.0	0.0	0.0	0.0
6	2016/2/26	16:31:49	00:01	24	F	K	0.0	0.0	0.0	0.0
7	2016/2/26	16:32:20	00:01	13	F	K	0.0	0.0	0.0	0.0
8	2016/2/26	16:32:39	00:01	13	F	K	0.0	0.0	0.0	0.0
9	2016/2/26	16:32:59	00:01	7	F	K	0.0	0.0	0.0	0.0



for examples:

It will transfer first data set to graph on the right hand side. The user can also click at any other data set to choose that set for graph.

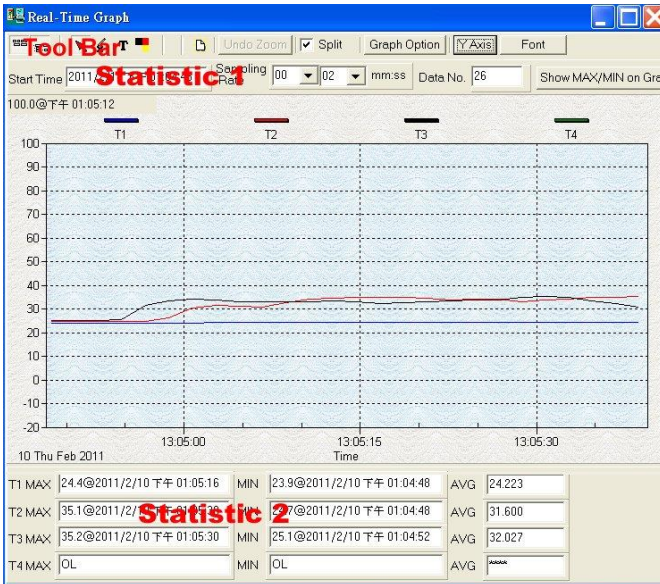
**Graph:**



**Tool Bar:**

-  - Display or hide Statistic1.
-  - Display or hide Statistic2.
-  - Normal cursor.



- When selected, the mouse cursor will become a cross sign when moving to the graph, click on the graph to mark a cross sign on the graph. This is available only when " **Split** " option is unchecked. And all the mark you make will exist with T1.



- When selected, the mouse cursor will become a " I " sign when moving to the graph, click on the graph to annotate. This is available only when " **Split** " option is unchecked. And all the text you make will exist with T1.



- Separate the four channel.

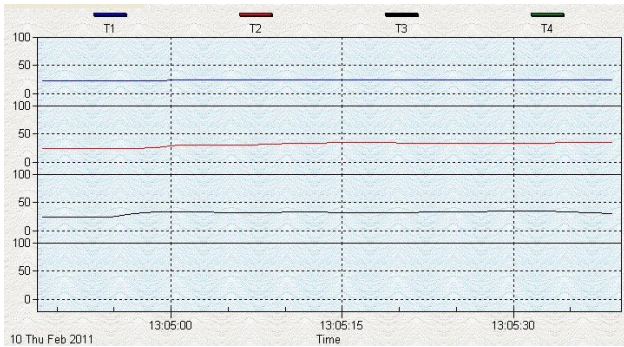

- Combine the four channel.

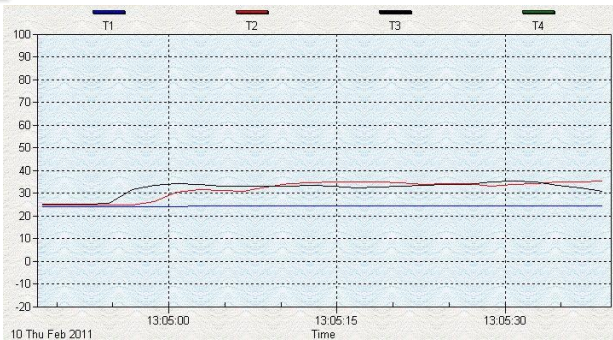

**Graph Option**

- Graph Customization

**Y Axis**

- Change the Y axis extension

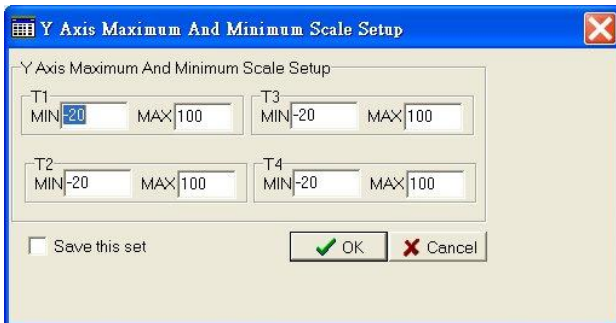

**Note:** When the Split is unchecked, graph will use T1 as the Y axis display range.



You can Zoom this graph by using mouse:

To Zoom:

- (1) Press the left mouse button and drag the cursor to select the new extents.
- (2) Release the mouse button.

You can choose channel number showing in the graph.

- a. Click "**Graph Option**" to call Customization dialog.
- b. Select Subsets tab.
- c. Select a single channel or multiselect (hold Ctrl key, use mouse to choose) channels.

## 10.9 Frequently Asked Question:

### (1) How to uninstall SE521 ?

**Answer:** Uninstall SE521 by launching the Add/Remove Programs applet out of the Control Panel, highlighting the SE521, and clicking on the Add/Remove... push button, then it will remove the SE521 folder and files from your computer.

### (2) How to zoom the graph?

**Answer:** Press the left mouse button and drag the cursor to select the new extents, then release the mouse button.

### (3) When I setup the real time sampling with a fast rate(eg. 1 sec), Some of the sampling data might be lost.

**Answer:** This might be caused by slow response time of the PC interface. For better result, the user may close the panel window.

### (4) How to continue to use the meter when the battery has run down ?

**Answer:** With USB interface powered directly, you can continue to use the meter.

## 10.10 Bluetooth Pairing:

### 10.10.1 Via ACTION CENTER (Windows 10)

- (1) Open [ ACTION CENTER ];
- (2) Click [ All Settings ];
- (3) Click [ Devices ];
- (4) Select [ Bluetooth ];
- (5) Turn On;
- (6) Select [ BT-xxxxxx ](serial number);
- (7) Click [ Pair ];
- (8) After installing, the device will appear as paired.

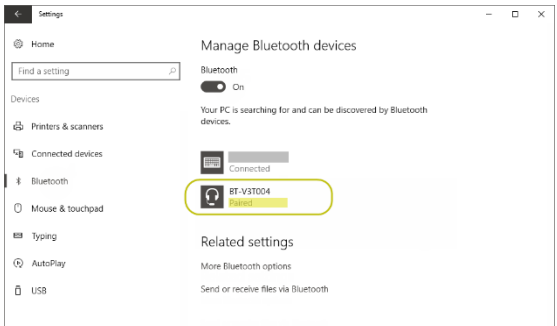
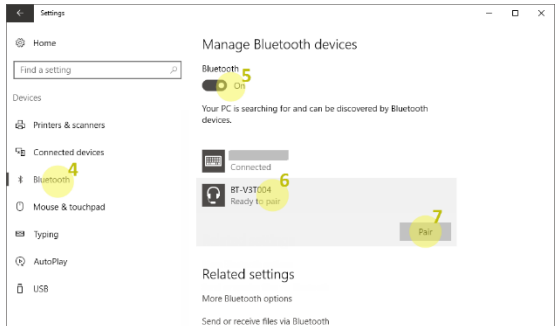
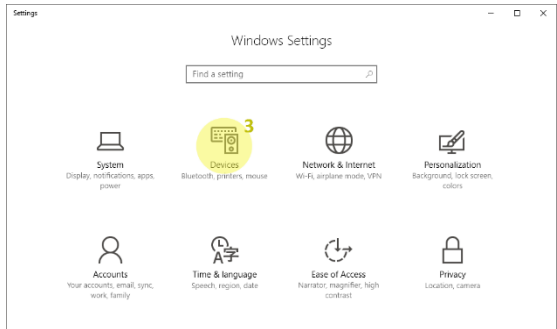
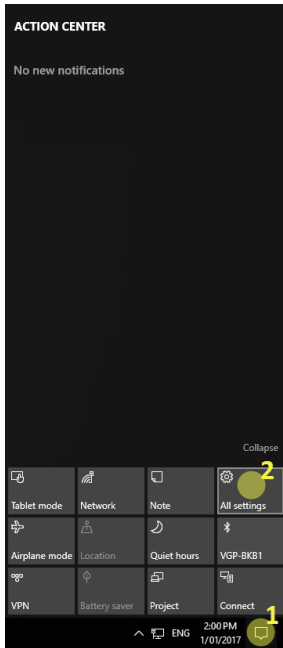

**10.10.2 Via Control Panel**

- (1) Click [ START ] and then click [ Devices and Printers ];
- (2) Click [ Add a device ];
- (3) Choose  BT-XXXXX Bluetooth Adapter , then click [ Next ].

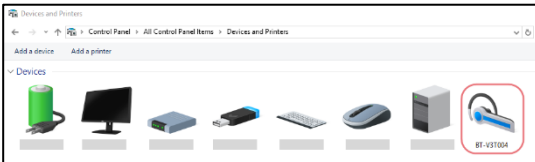
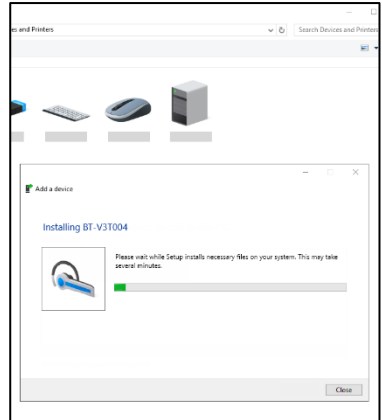
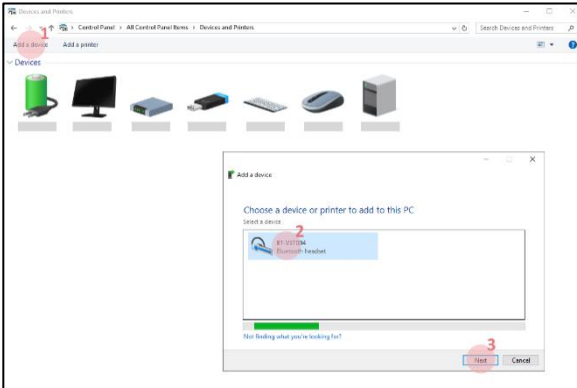

- (4) To find out which COM port has been allocated to the meter, click on the Windows Start button and search for “bluetooth” and choose “Change Bluetooth settings”

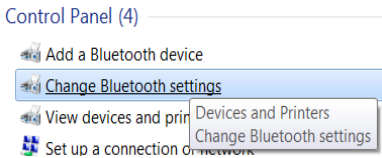

- (5) Click on the “COM Ports” tab to see which port has been allocated to the meter.

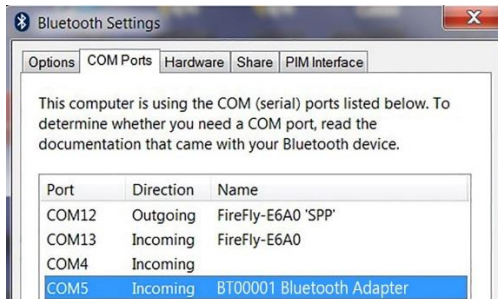



---

## Thermosense Limited

11 Eghams Court, Boston Drive, Bourne End, Bucks, SL8 5YS, UK

Telephone: +44 (0)1628 531166

Fax: +44 (0)1628 531499

Email: [sales@thermosense.co.uk](mailto:sales@thermosense.co.uk)

Web: [www.thermosense.co.uk](http://www.thermosense.co.uk)

---