

FMF Miniature Panel Inserts (Flanged)

Easy-to-install miniature flanged panel insert/socket for Thermocouple and RTD circuits that can be mounted with a stainless steel bracket and two screws, or with a stainless steel clip-spring (both supplied).

- Glass filled thermoplastic body with original thermocouple material pins and spring loaded inserts
- Polarized pins ensure proper connection
- Easy wire connection through sandwich construction
- Moulded barriers prevent short circuit
- Rugged one body design
- Polarity indication on body
- Stainless steel bracket and screws or stainless steel clip-spring mounting options (supplied)
- Panel cut-out: 8.1mm x 16.1mm
- ANSI colours also available

Bracket/screws

Clip-spring

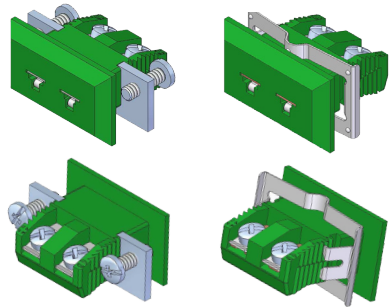

Wire Size

- Accepts wires up to 0.6mm

Temperature Rating

- +200°C Max.

Dimensions

- L1 = 14mm
- L2 = 23.5mm
- L3 = 19mm
- L4 = 28mm (including bracket/clip)

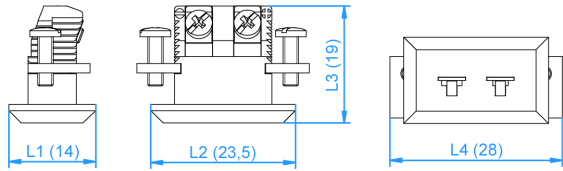

IEC code	K	J	T	N	E	R/S	B	C	RTD
socket code	FMF-K	FMF-J	FMF-T	FMF-N	FMF-E	FMF-R	FMF-B	FMF-C	FMF-U

FM Miniature Aluminium Connector Panels

Aluminium connector panels with 1-24 channel options to suit FMF-style miniature flanged panel inserts.

- Suits FMF-style miniature panel inserts
- 1, 2, 4, 6, 8, 12, 24 channel panels available
- 1 to 12 channel panels = single row
- 24 channel panels = double row

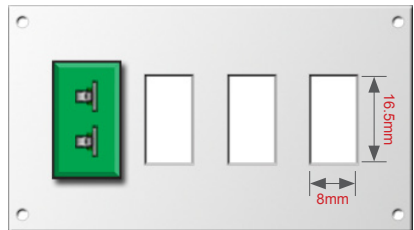
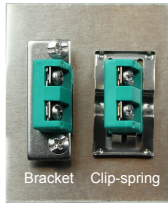

Note: quoted dimensions have a tolerance of +/- 1mm

Rear View Example

Note: inserts/sockets are not included with panels

number of channels	1	2	4	6	8	12	24
dimensions (W x H) mm	25 x 45	55 x 45	85 x 45	115 x 45	145 x 45	205 x 45	205 x 75
panel code	FM01	FM02	FM04	FM06	FM08	FM12	FM24

FP/FPL/FPH Pre-assembled Miniature Thermocouple Connector Panels

Pre-assembled, robust, miniature horizontal panel assemblies for thermocouple and RTD circuits. Ideal for mounting in control rooms, test stands, laboratory applications, pilot plants etc. Supplied pre-fitted with miniature panel inserts.

For use with the following calibration codes: K, J, T, N, E, R/S, B, C, RTD.

Each panel assembly includes: panel, insert/socket(s) and mounting bar. Available as: miniature horizontal, miniature horizontal locking and miniature horizontal high temperature.

- Aluminium front panel anodized for full corrosion protection
- All circuits identified with scratchproof numbering
- Stainless steel bar and brass nickel plated screws
- Pre-assembled with panel inserts
- Mounting construction will make it impossible to dislodge insert from panel
- Angled screws on the insert will allow wiring of the panel after mounting
- Flush surface for easy cleaning
- Available as miniature horizontal, horizontal locking and horizontal high temperature

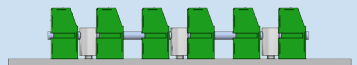
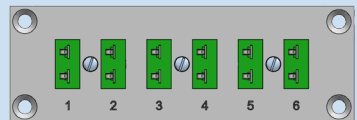

Top view showing stainless steel bar and panel inserts

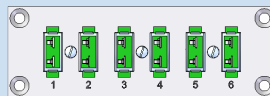

Locking Panel Assembly

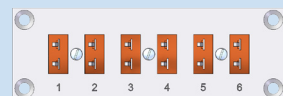

High Temperature Panel Assembly

Contact sales for further information

