

HDT-318 Thermo-Hygrometer with Data Logger (Air Humidity/Temperature)

Instruction Manual



CONTENTS

1. SAFETY INFORMATION	2
2. GENERAL DESCRIPTION	2
3. FEATURES.....	2
4. SPECIFICATIONS	3
5. SYMBOL BUTTONS AND FUNCTIONS	4
6. DATA LOGGER	7
7. SETTING THE TIME.....	8
8. POWER PREPARATION	8
9. COMMUNICATION WITH A PC.....	9
TESTLINK SE-318 SOFTWARE	9
10. MAINTENANCE	13
11. CONNECTION BETWEEN PROBE AND DEVICE	13

1. SAFETY INFORMATION

Read the following safety information carefully before attempting to operate or service the meter. Use the meter only as specified in this manual; otherwise the protections provided by the meter may be impaired.

ENVIRONMENT CONDITIONS:

- Altitude up to 2000 meters
- Relatively humidity: 90% max
- Operation ambient temperature: 0 to 40°C

MAINTENANCE & CLEARING:

- Repairs or servicing not covered in this manual should only be performed by qualified personnel.
- Periodically wipe the case with a dry cloth. Do not use abrasives or solvents on this instrument.

SAFETY SYMBOLS:



When servicing, use only specified replacement parts.

2. GENERAL DESCRIPTION

Thank you for choosing our Thermo-Hygrometer Data Logger. To ensure the safety and the best performance of this instrument, we recommend you read and follow the manual carefully before any operation.

Measurement settings and results are shown on the backlit LCD panel.

Data can be stored in the meter or directly saved on a computer through the PC interface. Recorded data can be further processed on a computer.

3. FEATURES

- High accuracy
- Thermistor sensor for temperature measurement, fast response time
- Backlit dual display
- Dew point measurement
- Records up to 16,000 records
- PC Interface
- Free Windows software
- Auto power off for battery saving

4. SPECIFICATIONS

Sensor type: Electronic capacitance polymer film sensor / NTC

Relative humidity range: 0 to 100%RH

Temperature range: -20 to 60°C (- 4 to 140°F)

Dew point temperature range: -20 to 60°C (- 4 to 140°F)

Resolution: 0.1%RH, 0.1°C, 0.1°F

Accuracy: (at 23°C)

<Probe: RP-32>

<10%RH, >90%RH	±4.0%RH
10%RH to 90%RH	±2.0%RH
-20 to 60°C (-4 to 140°F)	±0.8°C (±1.5°F)

<Probe: RP-31>

<10%RH, >90%RH	±5.0%RH
10%RH to 90%RH	±3.0%RH
15 to 35°C (60 to 95°F)	±0.8°C (±1.5°F)
<15°C (60°F), >35°C (95°F)	Refer to chart

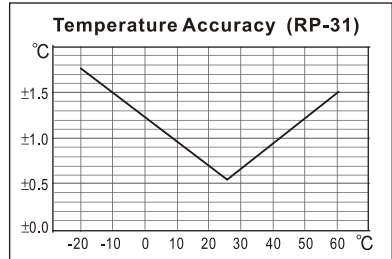

Response time: (@ t90; in slowly moving air) ; Humidity: 60 sec. ; Temperature: 10 sec.

Sensor hysteresis: <1.5%RH

Temperature coefficient: 0.1 x (specified accuracy) per 1°C (<23°C or >23°C)

Sample rate: 2 times per second

Battery type: 9V Battery

Battery lifetime: Approx. 80 hours (alkaline battery)

AC adapter: 9V DC(7~10V Max.)/20mA Min (Plug Diameter: 3.5mmx1.35mm)

Operation temperature: 0 to 40°C (32 to 104°F)

Operation humidity: 10 to 90%RH

Storage temperature: -10 to 60°C (14 to 140°F)

Storage humidity: 10 to 75%RH

Dimensions:

Meter: 185mm(L) x 65mm(W) x 36mm(H)

Probe: **RP-32:** 15mm Diameter x 94mm(L); **RP-31:** 15mm Diameter x 82mm(L)

Weight: Approx. 285g

Standard Accessories:

Instruction manual, 9V Battery, windows software, carrying case, USB cable.

Optional Accessories:

AC adapter, RS-232 Cable, Extension cables, 33%RH/ 75%RH humidity standard.

5. SYMBOL BUTTONS AND FUNCTIONS

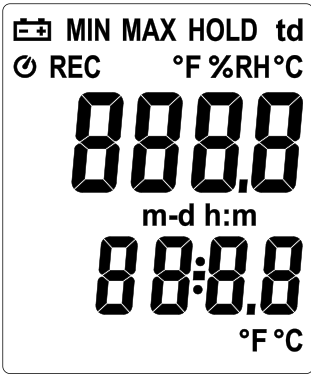

	: Low battery indicator
	: Auto power off indicator
MIN MAX	: Minimum / maximum indicator
188.8	: Relative Humidity reading
REC	: Recording data logger indicator
td	: Dew point temperature
HOLD	: Data hold indication
m-d	: Month-day
h:m	: Hour: minute
188.8	: Temperature reading
°C°F	: Temperature measurement units

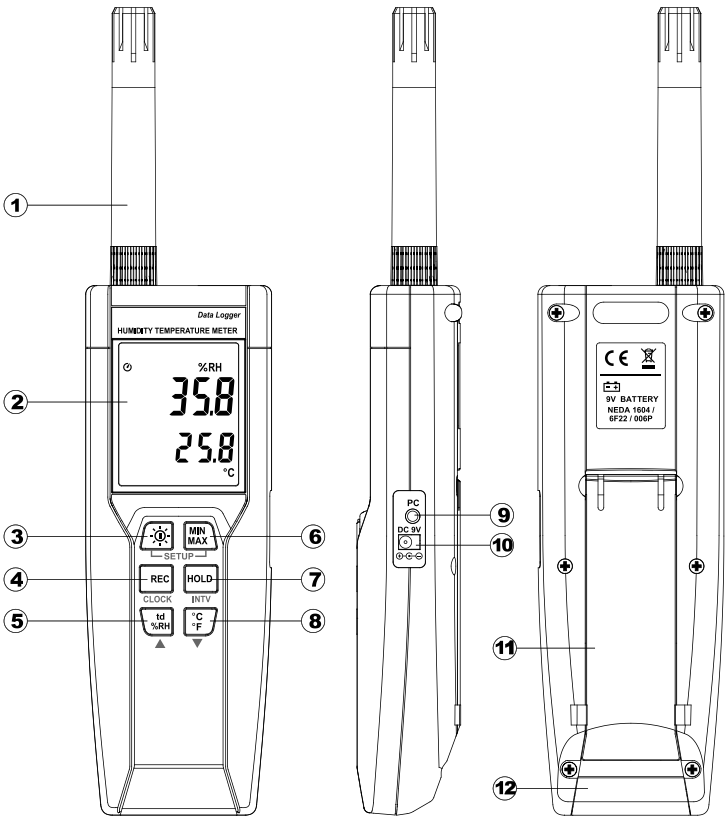



FUNCTIONS:

1 Sensor probe

2 Display screen

3 Power / Backlight button



Power on/off:

Press the  button to turn on the unit. To turn the unit off, press and hold  button down until the screen shows "OFF 3, 2, 1, 0," then the LCD screen goes off.

Note:

When the unit is on, the LCD will show the following initial information before entering the main function: **Available memory**→**Current date**→**Current time**→**Entering main function**

LCD backlight on/off:

Press  button to turn on the LCD backlight, making it easier to read in dark environment. Press  button again to turn off backlight. The backlight will turn itself off automatically after 30 seconds to save battery power.





Auto power off:

To save battery life, by default, every time the unit is powered on, it is under auto power off mode. The unit will power itself off after 30 minutes if no key operation.



Auto power off will be automatically disabled under the following 2 circumstances:

- When connecting to PC.
- When data logger function is in process.



Disabled auto power off:

- (1) Turn off the unit.
- (2) Press and hold  button, and keep holding  button.
- (3) Press  button to turn on the unit.
- (4) The LCD shows the initial information and then enters main function.
- (5) Release  button.
- (6) Make sure the auto power off  symbol disappears from display screen.

4 REC button

Press  button to start recording data. The **REC** symbol will display on the screen. To stop recording, press  button again.





5 Relative Humidity/Dew Point Temperature switch

By default, the LCD displays Relative Humidity when the unit is powered on. To display dew point (DP) temperature, press  button. Press  button again to switch back to Relative Humidity.

6 MAX/MIN mode

Under this mode, the unit simultaneously monitors and stores the maximum and minimum value (both humidity and temperature) in the memory. The unit will keep updating/refreshing the data.

To start:

- (1) Press  button. **MAX** symbol lights up on LCD, the reading shows the maximum data.
- (2) Press  button again to show minimum data; the **MIN** symbol lights up on LCD.
- (3) Press  button again, the **MAX** and **MIN** symbol blinks together. The reading shows present humidity and temperature.
- (4) Press  button again, **MAX** symbol lights up, and the mode returns to (1).



To exit:

Press and hold  button for 2 seconds to stop storing maximum and minimum data.

Note: When the unit is in the MAX/MIN mode,  button is disabled.

7 **Data-Hold mode**

Press  button to freeze the data shows on the LCD screen. Press again to exit Data-Hold mode.

Note: When the unit is in the Data-Hold mode, the , , and  buttons are disabled.

8 **Selecting temperature units**

By default, each time the unit is powered on, the scale is set to the Celsius (°C). Press the  button to switch between Celsius (°C) and Fahrenheit (°F).

9 **PC Interface**

The PC jack signal output is a 9600 bps N 8 1 serial interface. Use the USB cable (standard accessory) to connect with a computer.

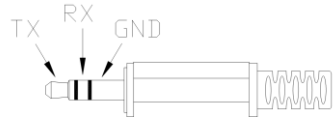

10 **External DC 9V power supply jack**

Connect the AC adapter (optional accessory) to use external power.







11 **Tilt stand**

12 **Battery Compartment**

6. DATA LOGGER

This section will explain how to store data (data logger) in memory and how to recall data from memory.

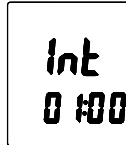

6.1 SETTING INTERVAL TIME FOR DATA STORING:

- (1) Turn off the unit.
- (2) Enter SETUP mode by pressing and holding  button and then press  power button to turn on the unit. "SEt" blinks on the LCD screen.
- (3) Press **INTV** () button to set interval time.
- (4) Press  (\uparrow td %RH) or  (\downarrow °C/°F) to adjust the interval minute, press **INTV** () button again to adjust second.
- (5) When finished, press **INTV** () button to exit SETUP mode.



Note: To abort during the process, press power button to exit SETUP mode.





6.2 START DATA LOGGER (STORING DATA IN THE MEMORY):

- (1) Press  button to start data logger (storing the measured values in built-in memory).
- (2) **REC** symbol lights up on LCD screen.
- (3) Press  button again to stop recording.

Note:

- During recording period, most of the buttons are disabled, such as the td %RH, °C/°F, etc. All other settings must be made before starting the data logger function.
- When the memory is full (16000 recorders), **REC** symbol will blink on the LCD screen. The data logger stops.
- When battery power low  symbol lights up on the screen), data logger cannot be started. If during data logger, the battery starts running low, data logger will stop automatically.

(3) CLEARING DATA:

- (1) Turn off the unit.
- (2) Press and hold  button and then press  power button to turn on the unit.
- (3) Keep holding  button, then LCD will show "CLr" and "SURE 5, 4...1, 0" until clean the memory. (To abort, release  button before "SURE 0".)

7. SETTING THE TIME

The unit incorporates a clock so that the data logger function can also record the data and time along with the measurement value in the memory.

7.1 SETTING DATE AND TIME:

- (1) Turn off the unit.
- (2) Enter SETUP mode by pressing and holding **MIN/MAX** button and then press **ON/OFF** power button to turn on the unit. "SET" blinks on the LCD screen.
- (3) Press **CLOCK (REC)** button to set clock.
- (4) Press **▲ (td / %RH)** or **▼ (°C / °F)** to adjust year, press **CLOCK (REC)** button to adjust next value (**month → date → hour → minute**).
- (5) When finish, press **CLOCK (REC)** button to exit SETUP mode.

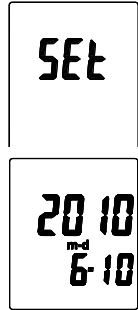

Note:

- To abort during the process, press power button to exit SETUP mode.
- An internal backup battery supplies power for the clock.

8. POWER PREPARATION

8.1 Battery Loading

Remove the battery cover on the back and insert one 9V battery.

8.2 Battery Replacement

When the battery voltage drops below the operating voltage, Low battery indicator **[- +]** will appear. Replace a 9 Volt battery immediately to ensure the unit functions properly.

8.3 AC Adapter Connection

When the AC adapter is used, insert the plugs of the adapter into the DC9V connector on the side panel.

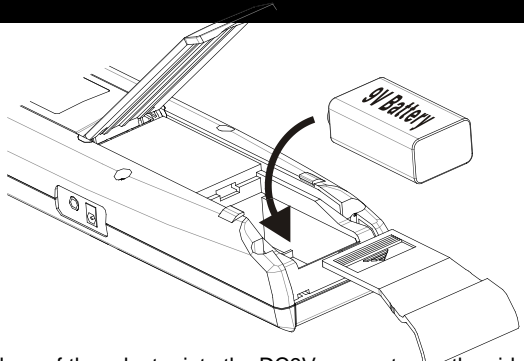

Note:

When the AC adapter is connected while battery is inserted, the unit will be powered from the adapter (the AC adapter has priority).

9. COMMUNICATION WITH A PC

Users can transfer data from the built-in memory on the instrument to a PC through the SE318 software. The communication requires a USB or RS-232 serial connection.

TESTLINK SE-318 SOFTWARE

(1) The SE-318 package contains:

- 80mm CD
- Custom designed USB cable for SE318

(2) System Required:

Windows NT 4.0/ NT2000/ XP/ VISTA/ Windows 7

(3) Minimum Hardware Required:

- PC or NoteBook with Pentium 800MHz or higher, 128 MB RAM
- At least 50 MB hard disk space available to install SE318
- Recommended screen resolution 1024X768 or above

(4) Install SE-318 and USB-120 connector driver:

1. We recommend you close all other applications before installing SE318.
2. Insert the setup CD disk and it should automatically display the install screen. You may also manually run MainSetup.exe from within the directory of the CD.
3. Click Install to begin installation.
4. The software will install the USB-120 connector driver first:
5. While installing, it will show this window below, just click “next” to continue.(see Fig.1)
6. Select “Launch the CP210x VCP Driver Installer” option, and then click Finish. (see Fig.2)

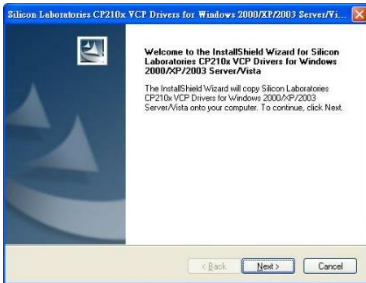

(Fig.1)

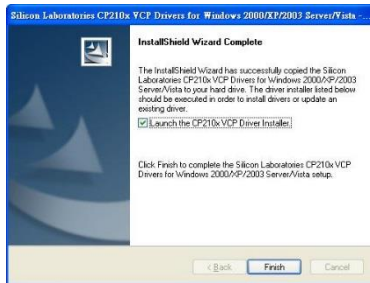

(Fig.2)

7. Click Install.

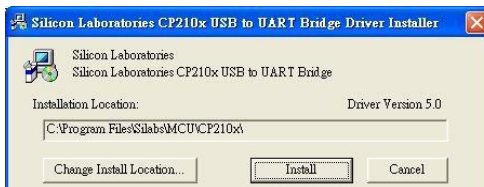



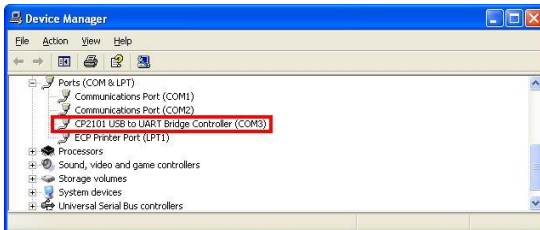
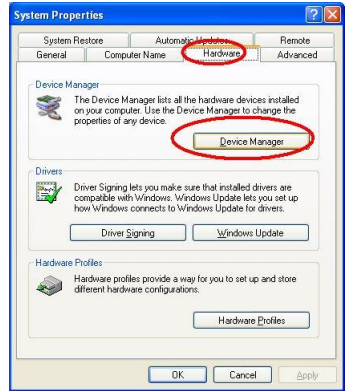



8. Once the USB-120 connector driver has installed it will install the SE318 software automatically.
9. Once installation has finished, connect the USB cable to the device and computer and switch the device on. Launch the SE318 software.
10. The software should detect which COM port the device is connected to. If it doesn't it will display "No Connection". To manually find the COM port launch **Device Manager**:
11. Launching Device Manager will vary depending on your computer's Windows operating system version:
 - a. Most versions: **Start Menu** -> Search for "**Device Manager**".
 - b. **Windows 7** -> Control Panel -> System and Security, **Windows Vista** -> Control Panel -> System and Maintenance, **Windows XP**-> Control Panel -> Performance and Maintenance.
12. Once Device Manager has loaded click the "+" symbol on the left side of Ports (COM & LPT). If the device "**CP2101 USB to UART Bridge Controller (COMx)**" is in the list, the COM port is shown and the connector is ready to work. If not, try reconnecting the device to a different USB port on the computer. Note: ensure the device is switched on.



(5) Main menu and buttons:



-  **Open** - Retrieve files from the disk
 -  **Save** - Save the present data to the disk
 -  **Print** - Send data in the present table to the printer
 -  **Pause** - Stop data recording
 -  **Run** - Start data recording
 -  **Output To Graph** - Send tabular data to another graph
 -  **New** - Reset all the data
- Option** - set attributes of graph. (You can also double click on the graph.)

Sampling Rate - Time interval between each data to be recorded. If you want to change it, move mouse cursor to the digit you want to change and click, then input the new sampling rate. The change will be effective immediately. It will keep up to 5000 data points, when data points exceed this limit, the oldest 100 points will be replaced sequentially.

(6) Real Time Graph:

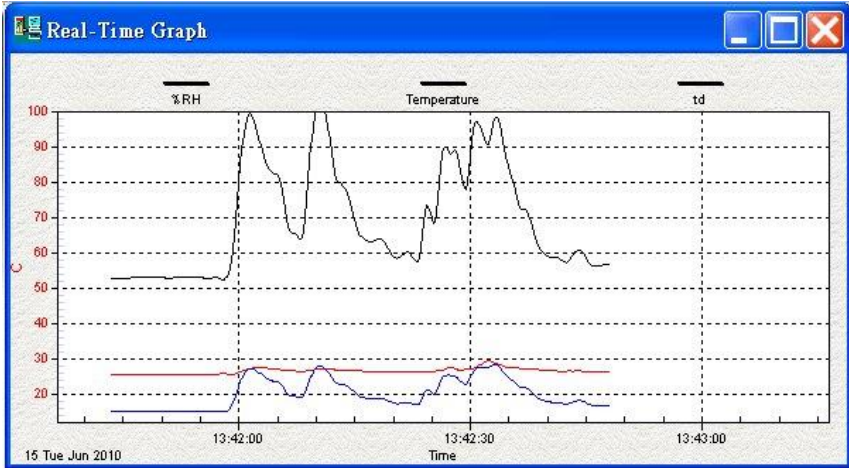

You can Zoom a graph by using the mouse:

To Zoom:

1. Press and hold the Shift key
2. Press the left mouse button and drag the cursor to select the new extents
3. Release the mouse button

To Undo the Zoom:

Press the Alt+U key or click the Undo Zoom button

Note: Zooming method is not allowed in Real Time Graph Window.

(7) Tabular:

NO	DATE	TIME	RH	T	td	UNIT
58	2010/6/15	13:42:40	58.5	26.6	17.6	C
59	2010/6/15	13:42:41	58.5	26.4	17.4	C
60	2010/6/15	13:42:42	57.2	26.4	17.1	C
61	2010/6/15	13:42:43	59.5	26.4	17.7	C
62	2010/6/15	13:42:44	60.4	26.4	18.0	C
63	2010/6/15	13:42:45	57.0	26.3	17.0	C
64	2010/6/15	13:42:46	56.1	26.2	16.6	C
65	2010/6/15	13:42:47	56.5	26.2	16.7	C
66	2010/6/15	13:42:48	56.4	26.2	16.7	C

The Tabular window can be used to record real time data in a table format. The maximum number of records that the Tabular window can keep will be depending on how many available memory and hard disk space of the connected computer.

(8) Data Logger

When you have thermometer connected to computer, select "Load Data" to start loading the recorded data from the thermometer. There will be a progress indicator to show the loading progress.

If error occurs, just click "Load Data" again.

After the data has been successfully loaded to computer, the left side window shows how many data sets were loaded and their detailed information (start date, start time, recording rate, and record numbers).

Data Sets				
Set	DATE	TIME	Rate	Nums
1	2010/5/7	下午 07:42:18	08:33	1
2	2010/5/7	下午 07:55:39	20:59	1
3	2010/6/25	下午 01:37:57	20:59	1
4	2010/6/25	下午 01:38:01	20:59	1
5	2010/6/25	下午 01:38:03	20:59	1
6	2010/6/25	下午 01:38:05	20:59	1
7	2010/6/25	下午 01:38:07	20:59	1
8	2010/6/25	下午 01:38:14	20:59	1
9	2010/6/25	下午 01:38:17	20:59	1
10	2010/6/25	下午 01:38:30	20:59	1
11	2010/6/25	下午 01:38:32	20:59	1

For example:

It will transfer the first data set to graph and tabular on the right side window once you finish loading recorded data from the thermometer. You can click on at any data set to show its graph and tabular on the right side window.

You can choose a rectangle area on the graph to zoom in for detail.

The vertical dash line in the graph will match the highlight row in the tabular. When clicking on another row in the tabular, the vertical dash line will move to the corresponding position to match the time.

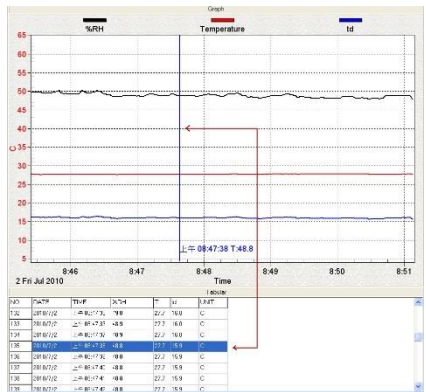

(9) Frequently Asked Questions:

Q: I have connected the thermometer to the computer turned it on but it still shows "NO CONNECTION"?

A: It could be caused by all COM ports being occupied by other applications. Close all application, restart your computer, and run SE318 again.

Q: In TABULAR window, I saved a file. Can I use EXCEL to open this file?

A: CSV (comma separated values) files can saved and opened in Excel. However, if your computer's regional settings use the comma as a decimal separator this will cause problems when opening the data within Excel. In this case you can use TXT files instead which use tabs to separate data, not commas.

Q: How do I uninstall the SE318 software?

A: You can uninstall SE318 software using the uninstall link within the start program menu on your computer. Alternatively launch the Add/Remove Programs application in the Windows Control Panel, highlighting the SE318, and clicking on the Add/Remove... button.

10. MAINTENANCE

In order to ensure the accuracy of the thermometer for a longer period of time you should calibrate it once a year.

Clean the device and the window of the display with a clean, lint-free, antistatic and dry cleaning cloth.

⚠ Do no use cleaning agents that contain carbon or benzenes, alcohol or anything similar to clean the product since these substances damage the surface of the measuring instrument. Moreover, these fumes are hazardous to health and explosive. Do not use tools with sharp edges, screwdrivers, metal brushes or anything similar to clean the device.

11. CONNECTION BETWEEN PROBE AND DEVICE

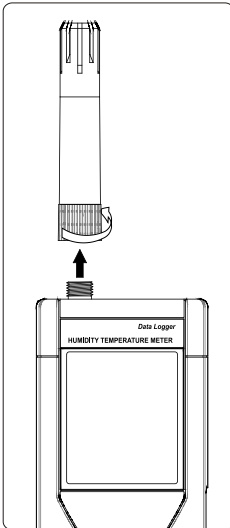

The probe can be connected or disconnected from the device by the fastening screw as shown in the graph. Rotate only the fastening screw rather than the probe body to prevent damage the probe.



Thermosense Limited

11 Eghams Court, Boston Drive, Bourne End, Bucks, SL8 5YS, UK

Telephone: +44 (0)1628 531166

Fax: +44 (0)1628 531499

Email: sales@thermosense.co.uk

Web: www.thermosense.co.uk
